

Danfoss



VLT® 2800
The general purpose drive



The pace-setter among general purpose drives

The VLT® 2800 series are among the smallest multi-purpose drives in the market, designed for space saving side-by-side mounting. Choose to have it with Motor Coils, RFI filter, LC+1B filters e.g.

The VLT® 2800 is designed as an advanced and versatile drive, yet easy to operate. Quick menu includes all basic parameters needed for commissioning the drive, offering fast installation and service.

An excellent price/performance have made the VLT® 2800 a pace-setter within general purpose drives.

In virtually any application, the VLT® 2800 has proved trustworthy, robust, easy to operate and commission.

A favourable price combined with reliability and a number of useful functionalities have made the VLT® 2800 a pace-setter within general purpose drives.

Trustworthy

One of the best selling drives in this power size:

- Real side by side mounting
- Easy to operate
- Start-up without major adjustments with "Quick Menu"
- Compact
- Robust – die-cast chassis, good heat dissipation,
- Protected against main transients
- Metasys for HVAC

- Hot pluggable display incl. copy function as option
- MCT-10
- Precise stop
- 24 hour support, local service
- DC-coil built in for harmonics
- Cold plate technology

Reliable EMC

The VLT® 2800 complies with the EMC norm EN 55011 Class 1A and 1B (with RFI filter).

Short circuit resistant

The VLT® 2800 will survive even short circuit of motor cables and short circuit of signal cables.

No derating at 40°

The VLT® 2800 will operate normally (no need for derating) in environment temperatures up to 40° C

Product safety

- 100% earth fault protection
- Mains transient protection
- Switching on input
- Switching on output
- Galvanic isolation
- Designed according to EN50178

Intelligent

- Multiple features makes VLT® 2800 an intelligent part of your system.
- Bus communication
 - Precise stop
 - Pump functions
 - Wobble functions

Bus communications

- DeviceNet
- Profibus DP
- ModBus RTU
- Metasys

The VLT® Motion Control Tool MCT 10 Setup Software exploits the full functionality of your PC, providing a general overview and control of even large systems.





Cold plate technology
Die-casted chassis

Various coded plugs

Hot pluggable display incl copy function.
SUB-D9 plug

Quick Menu Button

Real side-by-side mounting

Integrated heat control in IGBT

DC-coil built in

Dry run detection

New features improve pump operation significantly and result in improved energy savings as well as pump protection in case of dry run situations.

This new feature will protect the pump in case the well runs dry, by shutting down before damaging the pump.

Important features are:

- Automatic or manual restart after shut down
- Programmable restart delay up to one hour.
- Shut down at low or no flow
- Operates in either open or closed loop

Flexible mounting

VLT® 2800 is designed for flexible mounting. A ventilated heatsink allows for side by side mounting and even horizontal mounting.

User friendly

Entering motor data in the quick menu via the Local Control Panel is all you need to be up and running.

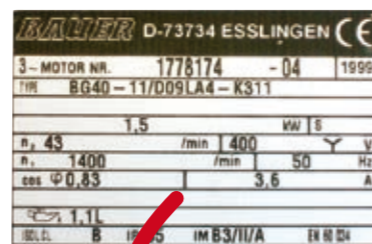

Enhanced sleep mode

When using pumps with flat pump curves or when the suction pressure varies, this feature provides excellent control for shutting down the pump at low flow, thus saving energy.

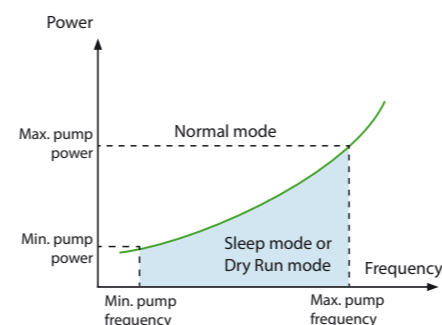

Important features are:

- Automatic restart after shut down based on pressure
- Boost function to increase pressure for a period after shut down
- Operates in closed loop

Pipe fill mode

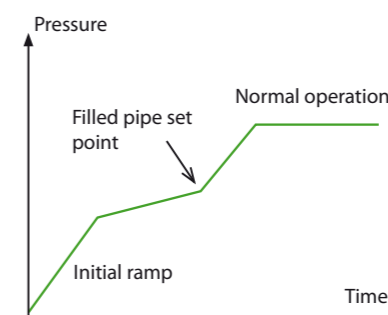

Pipe Fill Mode to prevent water hammering

Single-phase

VLT® 2800 provides three-phase power from a single-phase line outlet.

When a VLT® 2800 single-phase is used, it's just like getting three-phase power from a standard power socket – for pumps, fans, blowers etc. Now up to 3.7 kW (5 HP).

Applications operated by VLT® 2800

- Pump
- Fan
- Conveyor
- Extruder
- Mixer
- Wrapper
- Gantry Crane (small loads)
- Cutting
- Rotor spinning
- Winder
- Wobble

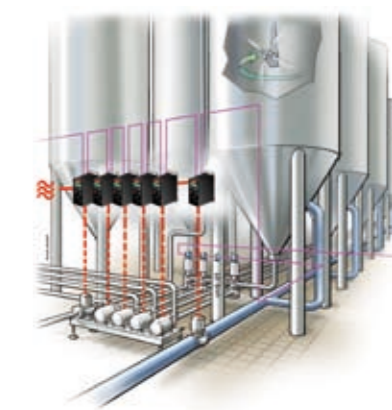
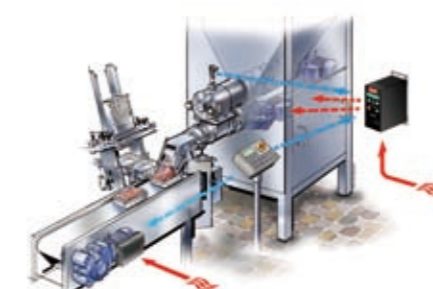
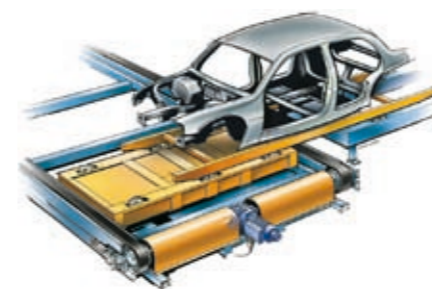
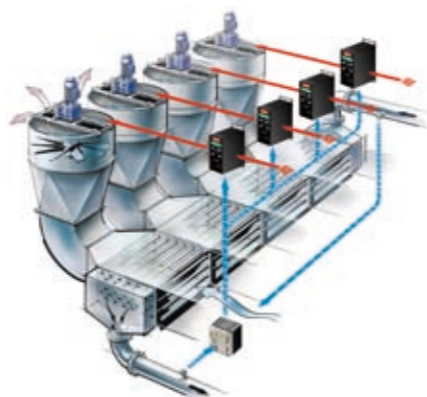
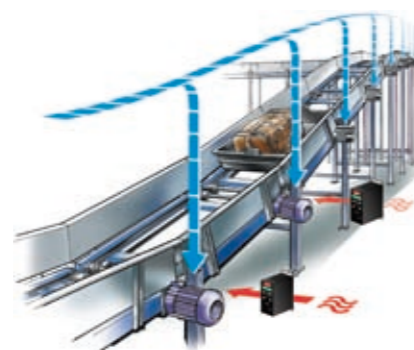
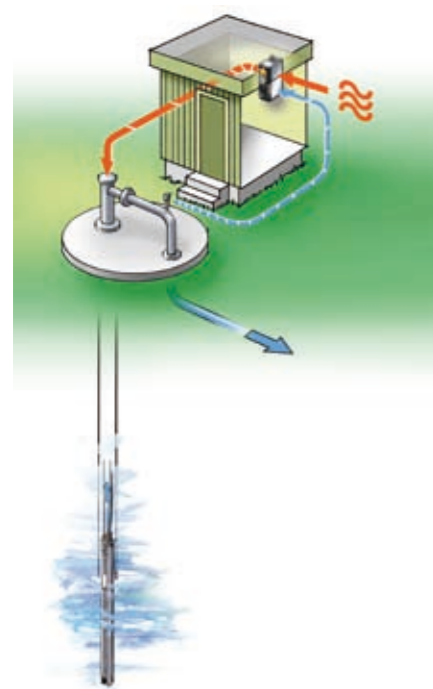

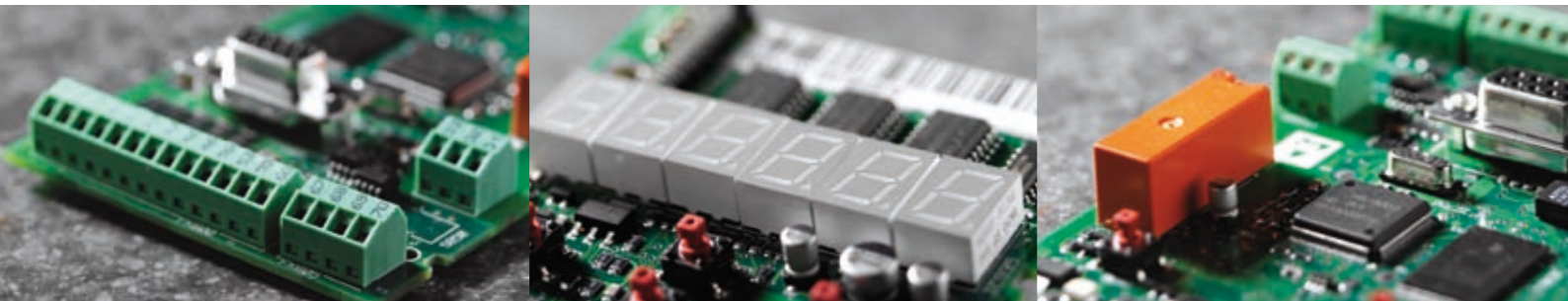

Galvanic insulated PELV terminals

Robust technology

Built in relay

Built in wobble function

The wobble function is used for the traverse function on a textile winder. VLT 2800 operates a motor, which turns a grooved drum. During winding, the grooved drum places the thread in the correct position on the bobbin, in a diamond pattern.

If the traverse (grooved) drum was operating at a constant speed, the thread would tend to cross at the same position for each pass, which would give a very loose and less compact winding on the bobbin.

Precise stop

Conventional units rely on a periodic scan of the digital inputs, which initiates the Stop command. This can result in uneven delays while the drive scans all the other parts of the program taking up to perhaps 10 ms. This is a disadvantage in typical packaging applications.

For a conveyor operating at a speed of 1 metre/second, that gives a deviation of ± 10 mm. In the VLT® 2800, the Stop command is an interrupt rather than part of the scan. The repeating precision is improved. The deviation is only ± 1 mm in the example used above.

Counter Precise Stop

After the start signal is received, the VLT® 2800 operates until the user programmed number of pulses is seen at terminal 33. A Stop signal is generated and the normal stop ramp is used. The counter stop signal is then re-armed and ready again for a new start command. The pulse input is designed to handle 24 V push-pull pulses from an encoder with up to 1024 ppr. The maximum pulse rate is 67,600 Hz.

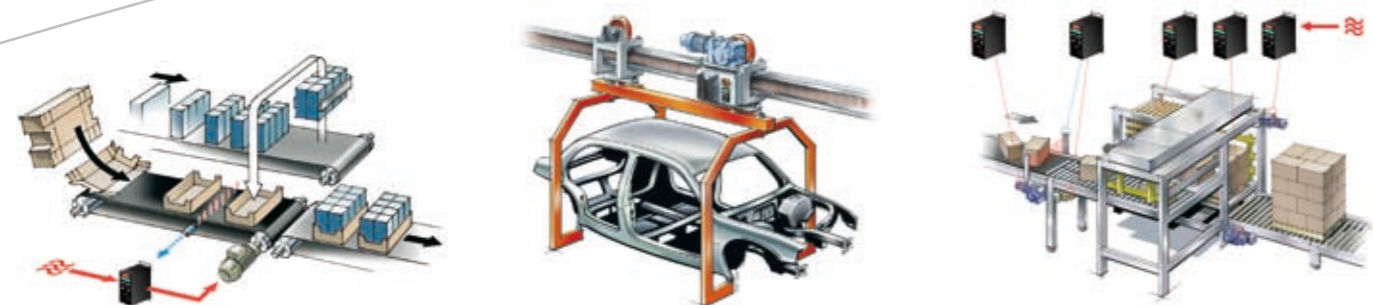
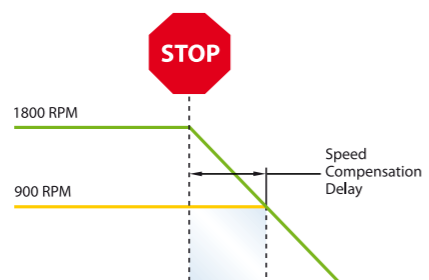
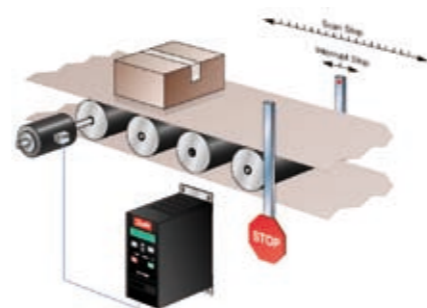

Specifications

Mains	Type	Typical shaft output				Input current	
		P _{N,M} [kW]	P _{N,M} [HP]	I _{INV} [A]	I _{MAX} (60s)	I _{LN} [A]	I _{L,MAX} (60s)
1 x 220-240 V	2803	0.37	0.5	2.2	3.5	5.9	9.4
	2805	0.55	0.75	3.2	5.1	8.3	13.3
	2807	0.75	0.75	4.2	6.7	10.6	16.7
	2811	1.1	1.5	6.0	9.6	14.5	23.2
	2815	1.5	2.0	6.8	10.8	15.2	24.3
	2822	2.2	3.0	9.6	10.6*	22.0	24.3
	2840	3.7	5.0	16.0	17.6*	31.0	34.5
3 x 200-240 V	2803	0.37	0.5	2.2	3.5	2.9	4.6
	2805	0.55	0.75	3.2	5.1	4.0	6.4
	2807	0.75	1.0	4.2	6.7	5.1	8.2
	2811	1.1	1.5	6.0	9.6	7.0	11.2
	2815	1.5	2.0	6.8	10.8	7.6	12.2
	2822	2.2	3.0	9.6	15.3	8.8	14.1
	2840	3.7	5.0	16.0	25.6	14.7	23.5
3 x 380-480 V	2805	0.55	0.75	1.7	2.7	1.6	2.6
	2807	0.75	1.0	2.1	3.3	1.9	3.0
	2811	1.1	1.5	3.0	4.8	2.6	4.2
	2815	1.5	2.0	3.7	5.9	3.2	5.1
	2822	2.2	3.0	5.2	8.3	4.7	7.5
	2830	3.0	4.0	7.0	11.2	6.1	9.8
	2840	4.0	5.0	9.1	14.5	8.1	13.0
	2855	5.5	7.5	12	19.2	10.6	17.0
	2875	7.5	10.0	16	25.6	14.9	23.8
	2880	11.0	15.0	24	38.4	24.0	38.4
2881	15.0	20.0	32	51.2	32.0	51.2	
2882	18.5	25.0	37.5	60.0	37.5	60	

* only 110% torque available

Mechanical dimensions [mm]

Height

A:	200	267.5	267.5	505
a:	191	257	257	490

Width

B:	75	90	140	200
b:	60	70	120	120

Depth

C:	168	168	168	244
----	-----	-----	-----	-----

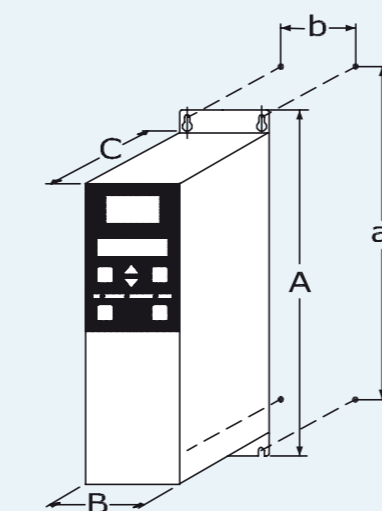

In- and output connections

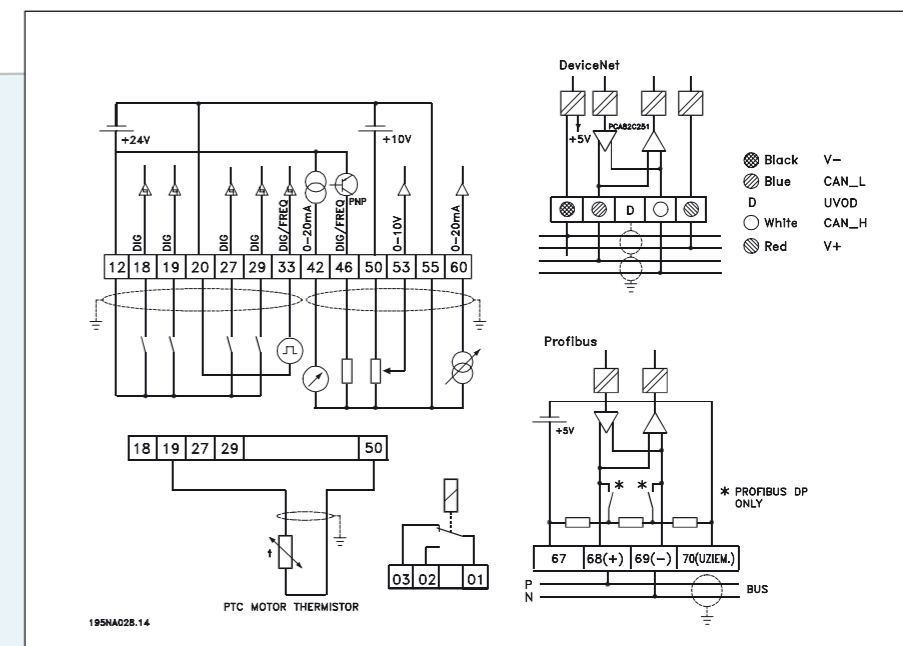



What VLT® is all about

Danfoss Drives is the world leader among dedicated drives providers – and still gaining market share.

The headquarters in Graasten, Denmark



Dedicated to drives

Dedication has been a key word since 1968, when Danfoss introduced the world's first mass produced variable speed drive for AC motors – and named it VLT®.

Two thousand employees develop, manufacture, sell and service drives and softstarters in more than one hundred countries – and nothing but drives and softstarters.

Local backup – globally

VLT® motor controllers are operating in applications all over the world and Danfoss Drives' experts located in more than 100 countries around the world are ready to support our customers with application advice and service wherever they may be. Danfoss Drives experts only ever stop when the customer's drive problems are solved.

Intelligent and innovative

Developers at Danfoss Drives have fully adopted modular principles in development as well as design, production and configuration. Tomorrow's features are developed in parallel using dedicated technology platforms. This allows the development of all elements to take place in parallel, at the same time reducing time to market and ensuring that customers always enjoy the benefits of the latest features.

Depend on the experts

We take responsibility for every element in our products. The fact that we develop and produce our own features, hardware, software, power modules, printed circuit boards, and accessories is your guarantee for reliable products.

